

# AOC

## LCD Monitor User Manual N941Sw



[www.aoc.com](http://www.aoc.com)

©2010 AOC. All Rights Reserved.

Safety.....	4
National Conventions.....	4
Power .....	5
Installation.....	6
Cleaning .....	7
Other.....	8
Setup .....	9
Contents in Box .....	9
Setup Stand & Base.....	10
Adjusting Viewing Angle.....	11
Connecting the Monitor.....	12
Wall Mounting .....	13
Adjusting .....	14
Setting Optimal Resolution .....	14
Windows Vista .....	14
Windows XP .....	16
Windows ME/2000.....	17
Hotkeys.....	18
OSD Setting.....	19
Luminance .....	20
Image Setup .....	22
Color Temperature .....	24
Color Boost.....	26
Picture Boost .....	28
OSD Setup .....	30
Extra .....	32
Reset .....	34
Exit .....	36
LED Indicator.....	37
Driver .....	38
Monitor Driver .....	38
Windows 7 .....	38
Windows Vista .....	42
Windows XP .....	44
Windows 2000.....	47
Windows ME.....	47
i-Menu.....	48
Troubleshoot.....	49
Specification.....	51
General Specification.....	51
Preset Display Modes.....	52
Pin Assignments .....	53
Plug and Play.....	54
Regulation.....	55
FCC Notice .....	55
WEEE Declaration .....	56

HG Declaration .....	56
EPEAT Declaration .....	57
Service .....	58
Warranty Statement for Europe.....	58
Warranty Statement for North & South America (excluding Brazil) .....	60
Warranty Statement for AP .....	62

# Safety

## National Conventions

The following subsections describe notational conventions used in this document.

### Notes, Cautions, and Warnings

Throughout this guide, blocks of text may be accompanied by an icon and printed in bold type or in italic type. These blocks are notes, cautions, and warnings, and they are used as follows:



**NOTE:** A NOTE indicates important information that helps you make better use of your computer system.





**CAUTION:** A CAUTION indicates either potential damage to hardware or loss of data and tells you how to avoid the problem.





**WARNING:** A WARNING indicates the potential for bodily harm and tells you how to avoid the problem. Some warnings may appear in alternate formats and may be unaccompanied by an icon. In such cases, the specific presentation of the warning is mandated by regulatory authority.

## Power

 The monitor should be operated only from the type of power source indicated on the label. If you are not sure of the type of power supplied to your home, consult your dealer or local power company.

 The monitor is equipped with a three-pronged grounded plug, a plug with a third (grounding) pin. This plug will fit only into a grounded power outlet as a safety feature. If your outlet does not accommodate the three-wire plug, have an electrician install the correct outlet, or use an adapter to ground the appliance safely. Do not defeat the safety purpose of the grounded plug.

 Unplug the unit during a lightning storm or when it will not be used for long periods of time. This will protect the monitor from damage due to power surges.

 Do not overload power strips and extension cords. Overloading can result in fire or electric shock.

 To ensure satisfactory operation, use the monitor only with UL listed computers which have appropriate configured receptacles marked between 100 - 240V AC, Min. 5A

 The wall socket shall be installed near the equipment and shall be easily accessible.

 For use only with the attached power adapter (Output 12Vdc) which have UL, CSA listed license (Only for monitors with power adapter).

# Installation

**!** Do not place the monitor on an unstable cart, stand, tripod, bracket, or table. If the monitor falls, it can injure a person and cause serious damage to this product. Use only a cart, stand, tripod, bracket, or table recommended by the manufacturer or sold with this product. Follow the manufacturer's instructions when installing the product and use mounting accessories recommended by the manufacturer. A product and cart combination should be moved with care.

**!** Never push any object into the slot on the monitor cabinet. It could damage circuit parts causing a fire or electric shock. Never spill liquids on the monitor.

**!** Do not place the front of the product on the floor.

**!** If you mount the monitor on a wall or shelf, use a mounting kit approved by the manufacturer and follow the kit instructions.

**!** Leave some space around the monitor as shown below. Otherwise, air-circulation may be inadequate hence overheating may cause a fire or damage to the monitor.

See below the recommended ventilation areas around the monitor when the monitor is installed on the wall or on the stand:

## Installed on the wall

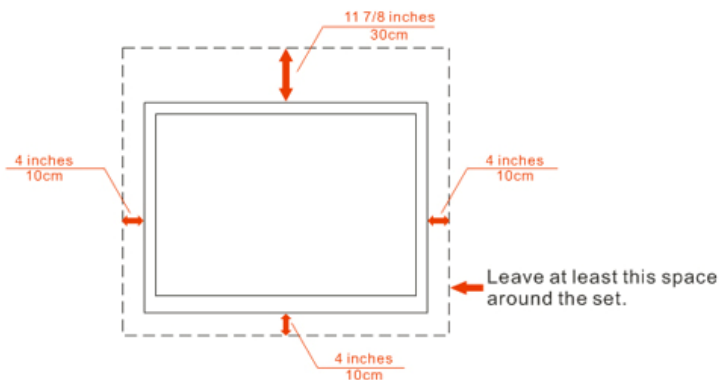

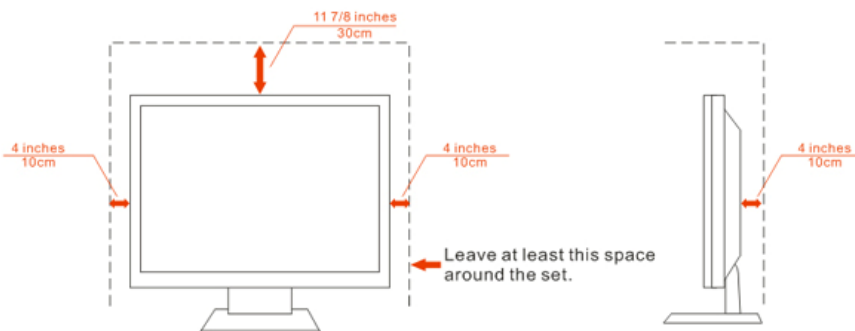

## Installed with stand



## Cleaning

 Clean the cabinet regularly with the cloth provided. You can use soft-detergent to wipe out the stain, instead of strong-detergent which will cauterize the product cabinet.

 When cleaning, make sure no detergent is leaked into the product. The cleaning cloth should not be too rough as it will scratch the screen surface.

 Please disconnect the power cord before cleaning the product.



## Other

 If the product is emitting a strange smell, sound or smoke, disconnect the power plug IMMEDIATELY and contact a Service Center.

 Make sure that the ventilating openings are not blocked by a table or curtain.

 Do not engage the LCD monitor in severe vibration or high impact conditions during operation.

 Do not knock or drop the monitor during operation or transportation.

 Webcamera will be not provided for customers. Please check with the local dealer or AOC branch office for confirmation.



# Setup

## Contents in Box



Monitor

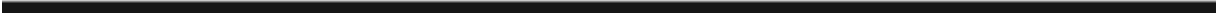

QSG



CD Manual



Monitor Base



Stand

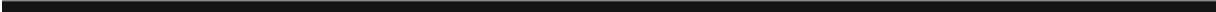

Power Cable

\*



Analog Cable

\*



USB Cable



Earphone Handle

\*



USB Camera

\* Not all signal cables (Analog, USB, DVI, and HDMI cables) will be provided for all countries and regions. Please check with the local dealer or AOC branch office for confirmation.

\* Webcam will be not provided for customers. Please check with the local dealer or AOC branch office for confirmation.

## Setup Stand & Base

Please setup or remove the base following the steps as below.

Setup:

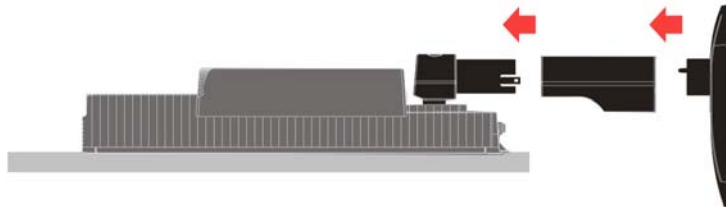

Remove:

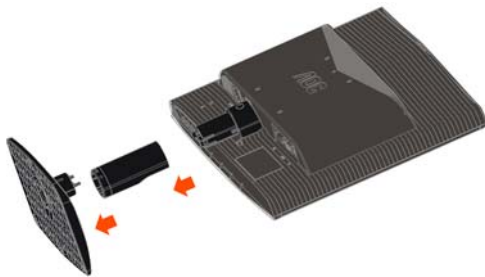

## Adjusting Viewing Angle

For optimal viewing it is recommended to look at the full face of the monitor, then adjust the monitor's angle to your own preference.

Hold the stand so you will not topple the monitor when you change the monitor's angle.

You are able to adjust the monitor's angle from  $-5^{\circ}$  to  $20^{\circ}$ .

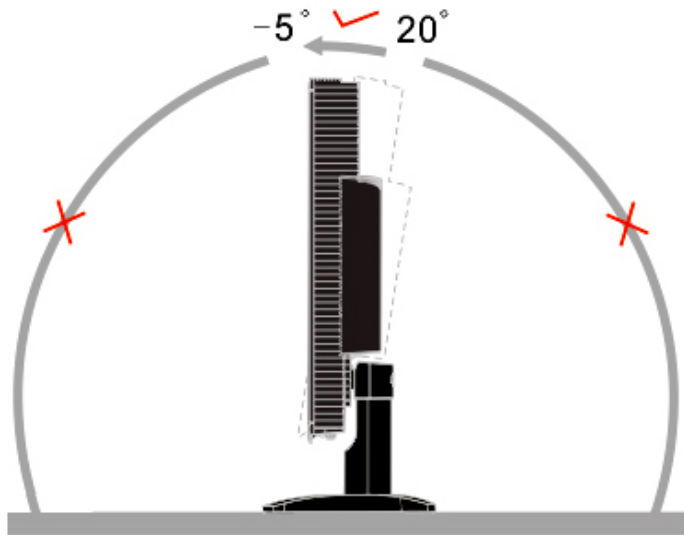

NOTE:

Do not touch the LCD screen when you change the angle. It may cause damage or break the LCD screen.

# Connecting the Monitor

Cable Connections On Back of Monitor and Computer:

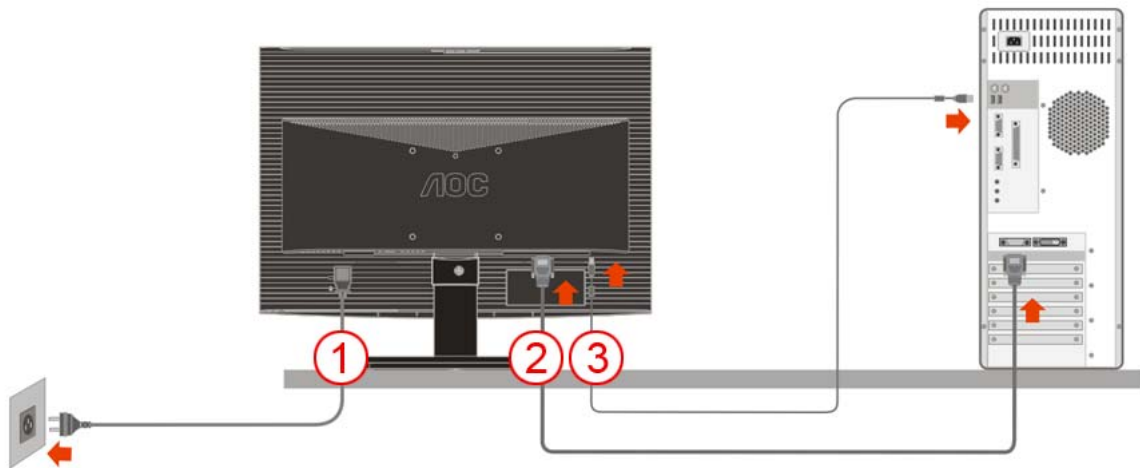

1. Power
2. Analog (DB-15 VGA cable)
3. USB

To protect equipment, always turn off the PC and LCD monitor before connecting.

- 1 Connect the power cable to the AC port on the back of the monitor.
- 2 Connect one end of the 15-pin D-Sub cable to the back of the monitor and connect the other end to the computer's D-Sub port.
- 3 Connect one end of the USB cable to the back of the monitor and connect the other end to the computer's USB port.
- 4 Turn on your monitor and computer.

If your monitor displays an image, installation is complete. If it does not display an image, please refer Troubleshooting.

# Wall Mounting

Preparing to Install An Optional Wall Mounting Arm.



This monitor can be attached to a wall mounting arm you purchase separately. Disconnect power before this procedure. Follow these steps:

- 1 Remove the base and stand.
- 2 Follow the manufacturer's instructions to assemble the wall mounting arm.
- 3 Place the wall mounting arm onto the back of the monitor. Line up the holes of the arm with the holes in the back of the monitor.
- 4 Insert the 4 screws into the holes and tighten.
- 5 Reconnect the cables. Refer to the user's manual that came with the optional wall mounting arm for instructions on attaching it to the wall.

Noted : VESA mounting screw holes are not available for all models, please check with the dealer or official department of AOC.

# Adjusting

## Setting Optimal Resolution

### Windows Vista

For Windows Vista:

1 Click **START**.

2 Click **CONTROL PANEL**.



3 Click **Appearance and Personalization**.



4 Click **Personalization**



5 Click **Display Settings**.



6 Set the resolution **SLIDE-BAR** to 1366 by 768.

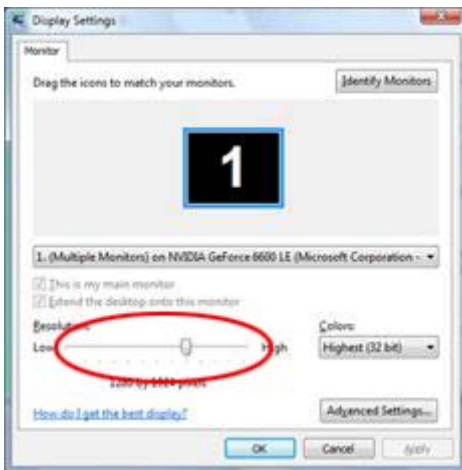

# Windows XP

For Windows XP:

1 Click **START**.



2 Click **SETTINGS**.

3 Click **CONTROL PANEL**.

4 Click **Appearance and Themes**.



5 Double click **DISPLAY**.





6 Click **SETTINGS**.

7 Set the resolution **SLIDE-BAR** to 1366 by 768.

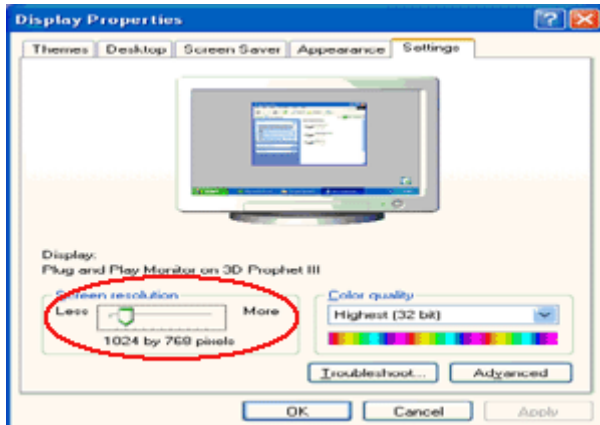

## Windows ME/2000

For Windows ME/2000:

1 Click **START**.

2 Click **SETTINGS**.

3 Click **CONTROL PANEL**.

4 Double click **DISPLAY**.

5 Click **SETTINGS**.

6 Set the resolution **SLIDE-BAR** to 1366 by 768.

# Hotkeys

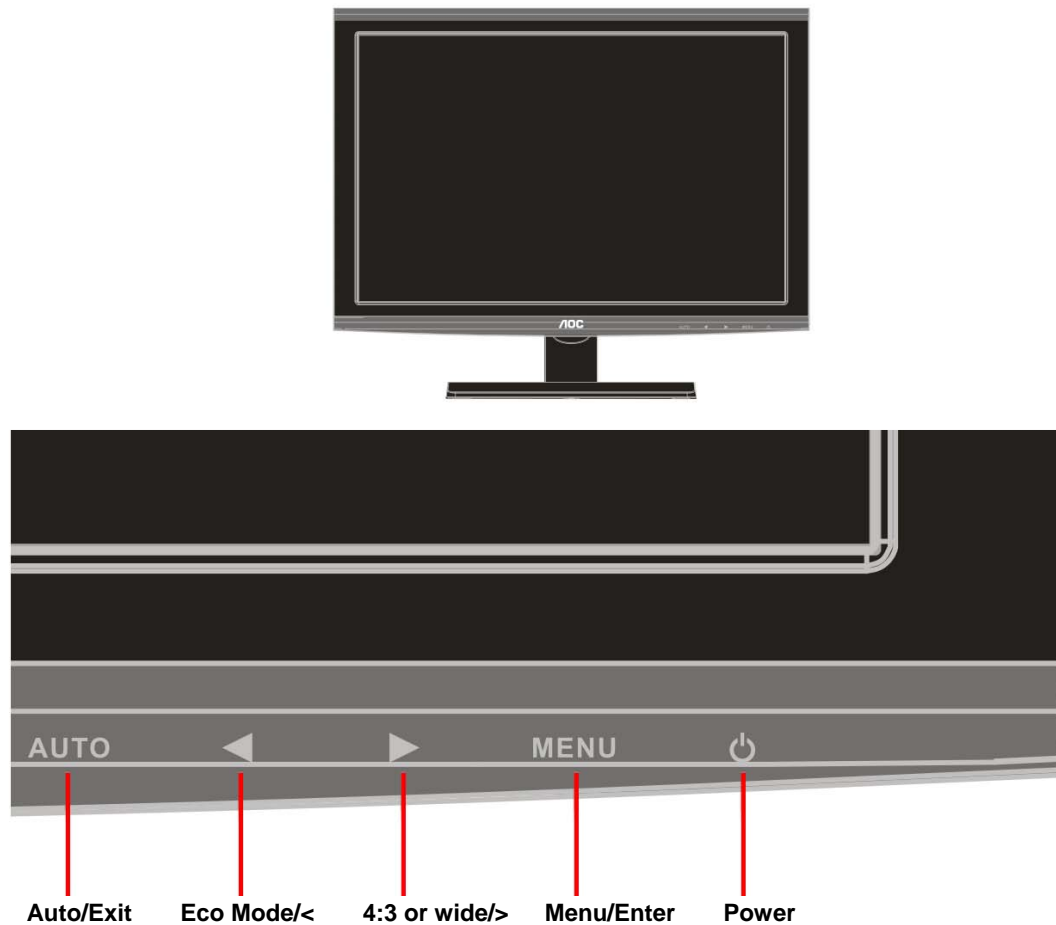

## Power

Press the Power button to turn On/off the monitor.

## Eco Mode / <

Press the Eco key continuously to select the Eco mode of brightness when there is no OSD ( Eco mode hot key may not be available in all models).

## 4:3 or wide image ratio / >

When there is no OSD, press > hotkey continuously to change 4:3 or wide image ratio. (If the product screen size is 4:3 or input signal resolution is wide format, the hot key is disable to adjust. )

## Auto / Exit

When the OSD is closed, press Auto button will be auto configure hot key function .

# OSD Setting

Basic and simple instruction on the control keys.



- 1) Press the **MENU-button** to activate the OSD window.
- 2) Press **< or >** to navigate through the functions. Once the desired function is highlighted, press the **MENU-button** to activate sub-menu . Once the desired function is highlighted, press **MENU-button** to activate it.
- 3) Press **< or >** to change the settings of the selected function. Press **< or >** to select another function in sub-menu . Press **AUTO** to exit . If you want to adjust any other function, repeat steps 2-3.
- 4) OSD Lock Function: To lock the OSD, press and hold the **MENU button** while the monitor is off and then press **power button** to turn the monitor on. To un-lock the OSD - press and hold the **MENU button** while the monitor is off and then press **power button** to turn the monitor on.

## Notes:

- 1) If the product has only one signal input, the item of "Input Select" is disable to adjust.
- 2) If the product screen size is 4:3 or input signal resolution is wide format, the item of "Image Ratio" is disable to adjust.
- 3) One of DCR, Color Boost, and Picture Boost functions is active, the other two function is turned off accordingly.

## Luminance

1



Press **MENU** (Menu) to display menu.

2



Press **<** or **>** to select  (Luminance), and press **MENU** to enter.

3











Press **<** or **>** to select submenu, press **MENU** to enter, and press **<** or **>** to adjust.

4



Press **AUTO** to exit.

	Brightness	0-100		Backlight Adjustment
	Contrast	0-100		Contrast from Digital-register.
	Eco mode	Standard		Standard Mode
		Text		Text Mode
		Internet		Internet Mode
		Game		Game Mode
		Movie		Movie Mode
		Sports		Sports Mode
	Gamma	Gamma1	Adjust to Gamma1	
		Gamma2	Adjust to Gamma 2	
		Gamma3	Adjust to Gamma 3	
	DCR	Off		Disable dynamic contrast ratio
		On		Enable dynamic contrast ratio

## Image Setup

1



Press **MENU** (Menu) to display menu.

2



Press **<** or **>** to select  (Image Setup), and press **MENU** to enter.

3



Press **<** or **>** to select submenu, press **MENU** to enter, and press **<** or **>** to adjust.

4



Press **AUTO** to exit.

	Clock	0-100	Adjust picture Clock to reduce Vertical-Line noise.
	Phase	0-100	Adjust Picture Phase to reduce Horizontal-Line noise
	H.Position	0-100	Adjust the horizontal position of the picture.
	V.Position	0-100	Adjust the vertical position of the picture.

## Color Temperature

1



Press **MENU** (Menu) to display menu.

2



Press **<** or **>** to select  (Color Temperature), and press **MENU** to enter.

3



Press **<** or **>** to select submenu, press **MENU** to enter, and press **<** or **>** to adjust.

4



Press **AUTO** to exit.



	Warm	6500K	Recall Warm Color Temperature from EEPROM.
	Normal	7300K	Recall Normal Color Temperature from EEPROM.
	Cool	9300K	Recall Cool Color Temperature from EEPROM.
	sRGB		Recall SRGB Color Temperature from EEPROM.
	User	Red	
Green			Green Gain Digital-register.
Blue			Blue Gain from Digital-register

## Color Boost

1



Press **MENU** (Menu) to display menu.

2



Press **<** or **>** to select  (Color Boost), and press **MENU** to enter.

3



Press **<** or **>** to select submenu, press **MENU** to enter, and press **<** or **>** to adjust.

4



Press **AUTO** to exit.

	Full Enhance	on or off	Disable or Enable Full Enhance Mode
	Nature Skin	on or off	Disable or Enable Nature Skin Mode
	Green Field	on or off	Disable or Enable Green Field Mode
	Sky-blue	on or off	Disable or Enable Sky-blue Mode
	AutoDetect	on or off	Disable or Enable AutoDetect Mode
	Demo	on or off	Disable or Enable Demo

## Picture Boost

1



Press **MENU** (Menu) to display MENU.

Press **<** or **>** to select  (Picture Boost); and press **MENU** to enter.

2



Press **<** or **>** to select Bright Frame.  
Select "on" to activate Picture Boost.

3



Press **<** or **>** to select submenu, press **MENU** to enter, and press **<** or **>** to adjust.

4



Press **AUTO** to exit.

	Frame Size	14-100	Adjust Frame Size
	Brightness	0-100	Adjust Frame Brightness
	Contrast	0-100	Adjust Frame Contrast
	H. position	0-100	Adjust Frame horizontal Position
	V.position	0-100	Adjust Frame vertical Position
	Bright Frame	on or off	Disable or Enable Bright Frame

## OSD Setup

1



Press **MENU** (Menu) to display menu.

2



Press **<** or **>** to select  (OSD Setup), and press **MENU** to enter.

3



Press **<** or **>** to select submenu, press **MENU** to enter, and press **<** or **>** to adjust.

4



Press **AUTO** to exit.

	OSD Setup		
	H.Position	0-100	Adjust the horizontal position of OSD
	V.Position	0-100	Adjust the vertical position of OSD
	Timeout	5-120	Adjust the OSD Timeout
	Transparence	0-100	Adjust the transparence of OSD
	Language		Select the OSD language

## Extra

1



Press **MENU** (Menu) to display menu.

2



Press **<** or **>** to select  (OSD Setup), and press **MENU** to enter.

3



Press **<** or **>** to select submenu, press **MENU** to enter, and press **<** or **>** to adjust.

4



Press **AUTO** to exit.



	Input Select	D-SUB	Select Analog Sigal Source as Input
	Auto Config	yes or no	Auto adjust the picture to default
	Image Ratio	wide or 4:3	Select wide or 4:3 format for display
	DDC/CI	yes or no	Turn ON/OFF DDC/CI Support
	Off timer	0 to 24hrs	Select DC off time
	Information		Show the information of the main image and sub-image source

# Reset

1



Press **MENU** (Menu) to display menu.

2



Press **<** or **>** to select  (Reset), and press **MENU** to enter.

3



Press **<** or **>** to select YES or NO.

4



Press **AUTO** to exit.

	Reset	yes or no	Reset the menu to default
-----------------------------------------------------------------------------------	-------	-----------	---------------------------

# Exit

1



Press **MENU** (Menu) to display menu.



2



Press **<** or **>** to select  (Exit);  
and press **MENU** to exit.

	Exit		Exit the main OSD
-------------------------------------------------------------------------------------	------	--	-------------------

# LED Indicator

Status	LED Color	
Full Power Mode	Green or Blue	
Active-off Mode	Orange or red	

# Driver

## Monitor Driver

### Windows 7

1. Start Windows® 7

2. Click on the **'Start'** button and then click on **'Control Panel'**.

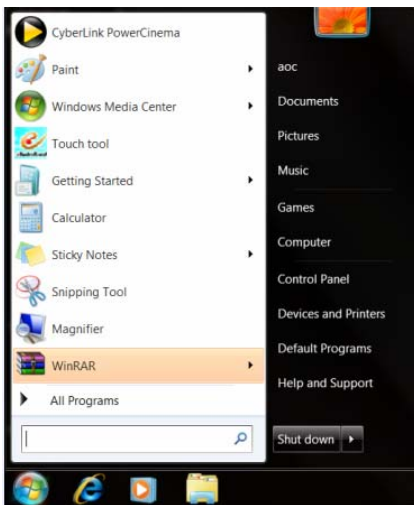

3. Click on the **'Display'** icon.

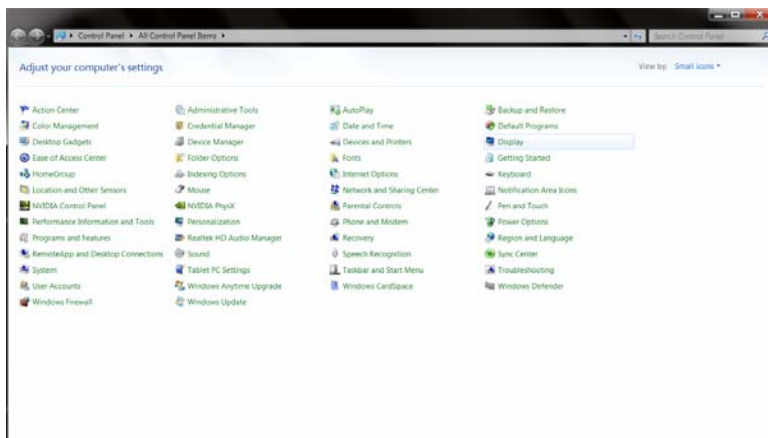

4. Click on the “Change display settings” button.

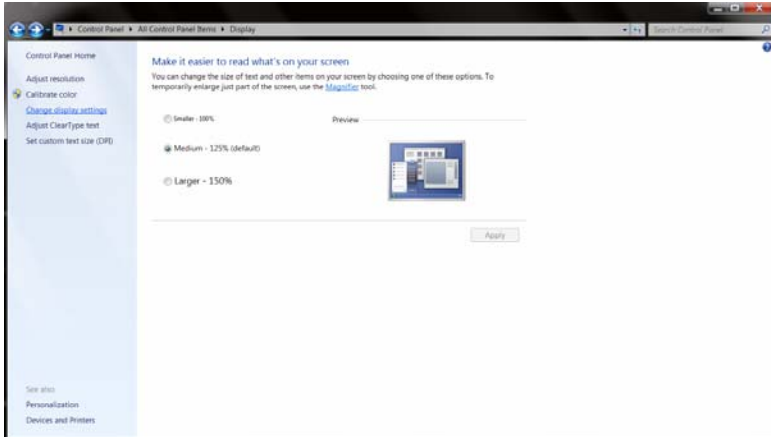

5. Click the “Advanced Settings” button.

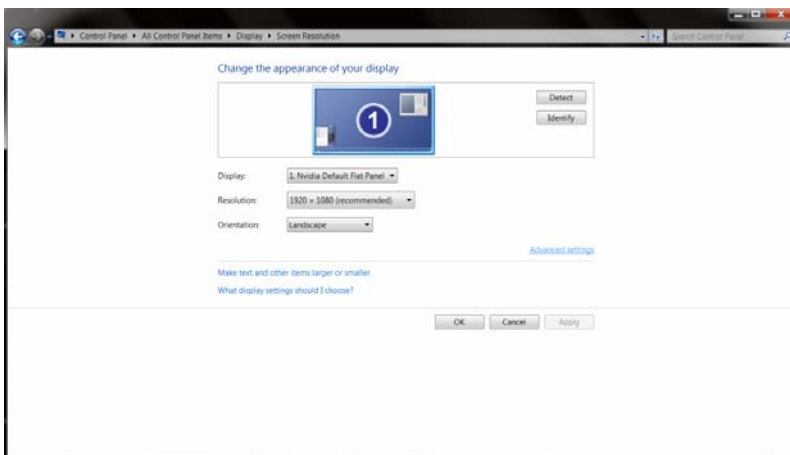

6. Click the “Monitor” tab and then click the “Properties” button.

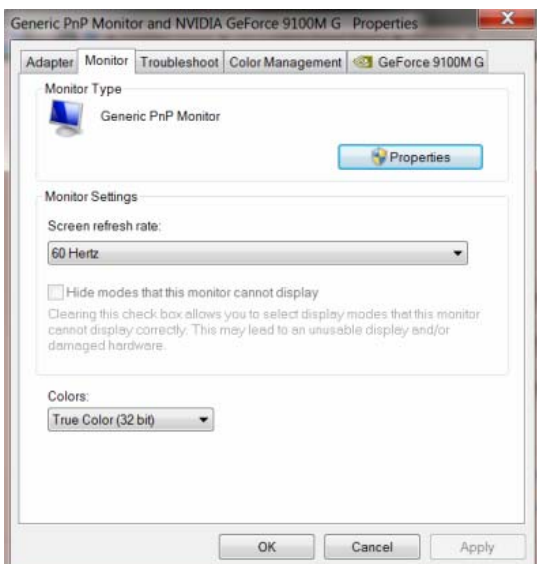

7. Click the **“Driver”** tab.

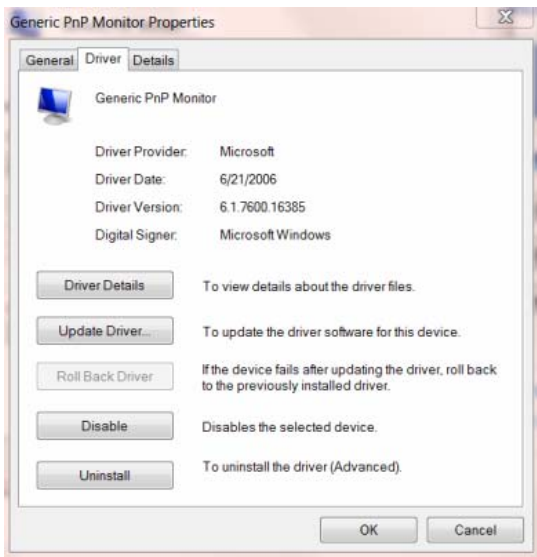

8. Open the "Update Driver Software-Generic PnP Monitor" window by clicking on **“Update Driver...”** and then click the **“Browse my computer for driver software”** button.

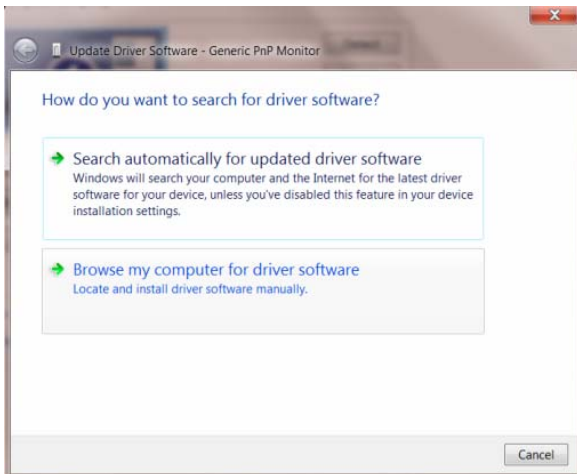

9. Select **“Let me pick from a list of device drivers on my computer”**.

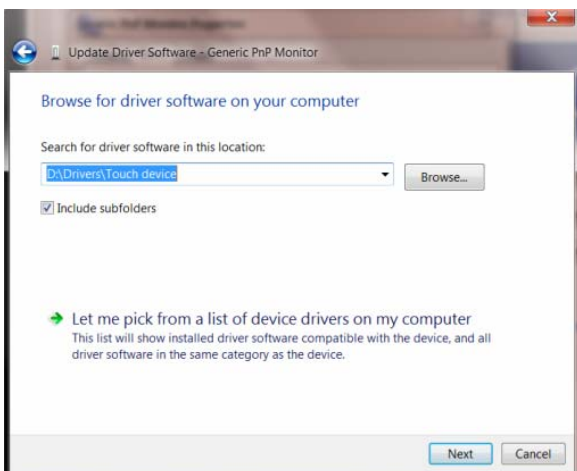



10. Click the **“Have Disk”** button. Click on the **“Browse”** button and navigate to the following directory:  
X:\Driver\module name (where X is the drive letter designator for the CD-ROM drive).

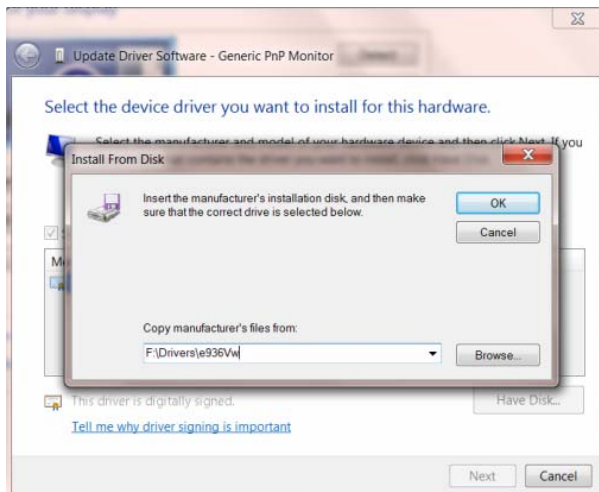

11. Select the **“xxx.inf”** file and click the **“Open”** button. Click the **“OK”** button.

12. Select your monitor model and click the **“Next”** button. The files will be copied from the CD to your hard disk drive.

13. Close all open windows and remove the CD.

14. Restart the system. The system will automatically select the maximum refresh rate and corresponding Color Matching Profiles.

# Windows Vista

1. Click "Start " and "Control Panel". Then, double-click on "Appearance and Personalization".



2. Click "Personalization" and then "Display Settings".

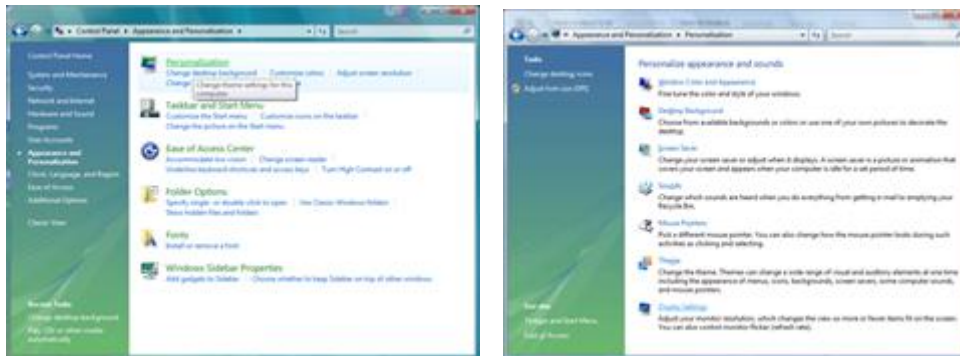

3. Click "Advanced Settings...".

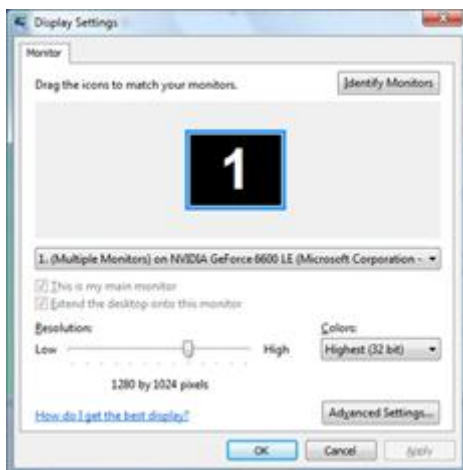

4. Click "Properties" in the "Monitor" tab. If the "Properties" button is deactivated, it means the configuration for your monitor is completed. The monitor can be used as is.

If the message "Windows needs..." is displayed, as shown in the figure below, click "Continue".

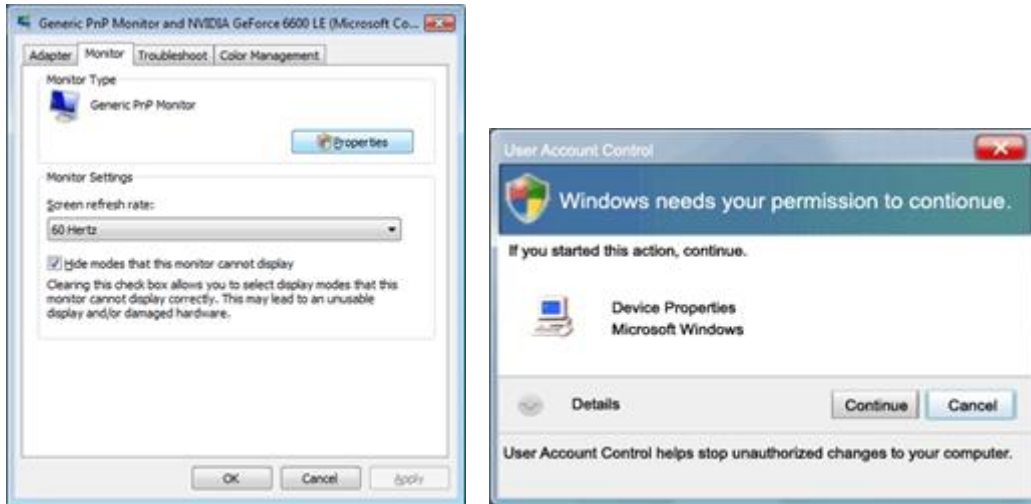

5. Click "Update Driver..." in the "Driver" tab.

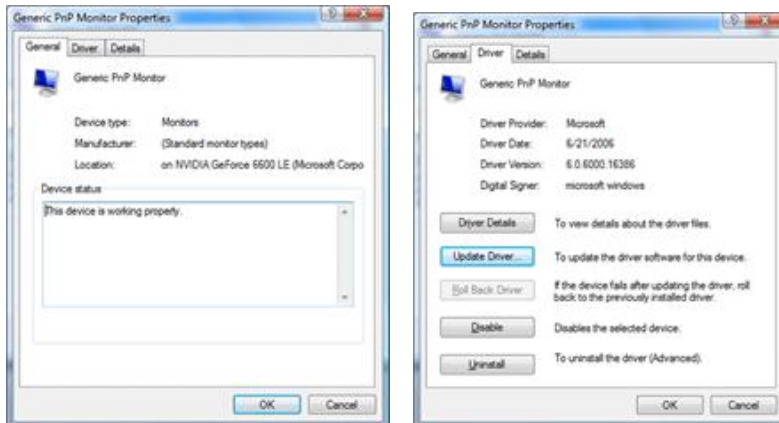

6. Check the "Browse my computer for driver software" checkbox and click "Let me pick from a list of device drivers on my computer".



7. Click on the 'Have disk...' button, then click on the 'Browse...' button and then select the appropriate drive F:\Driver (CD-ROM Drive).

8. Select your monitor model and click on the 'Next' button.

9. Click "Close" → "Close" → "OK" → "OK" on the following screens displayed in sequence.

# Windows XP

1. Start Windows® XP
2. Click on the 'Start' button and then click on 'Control Panel'.



3. Select and click on the category 'Appearance and Themes'

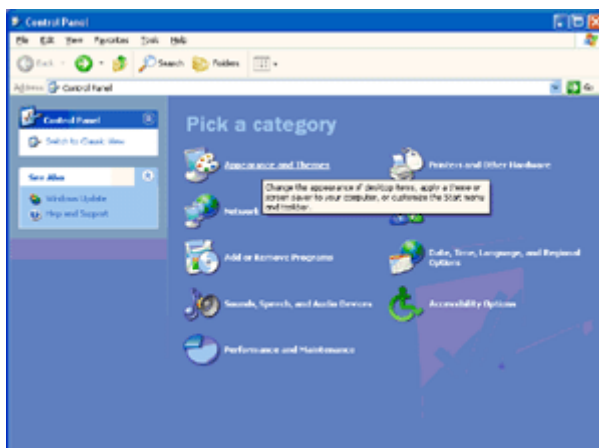

4. Click on the 'Display' Item.

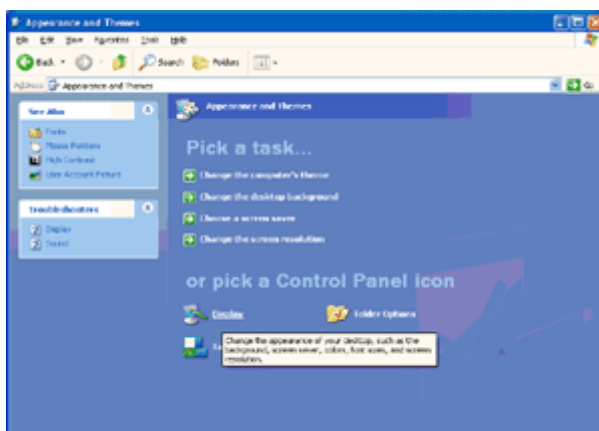

5. Select the 'Settings' tab then click on the 'Advanced' button.

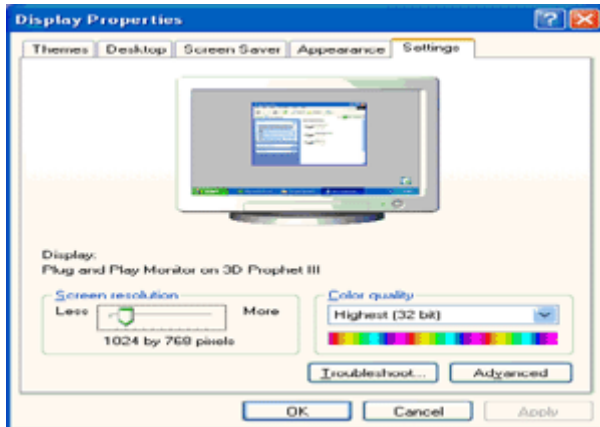

6. Select 'Monitor' tab

- If the 'Properties' button is inactive, it means your monitor is properly configured. Please stop installation.

- If the 'Properties' button is active, click on 'Properties' button.

Please follow the steps below.

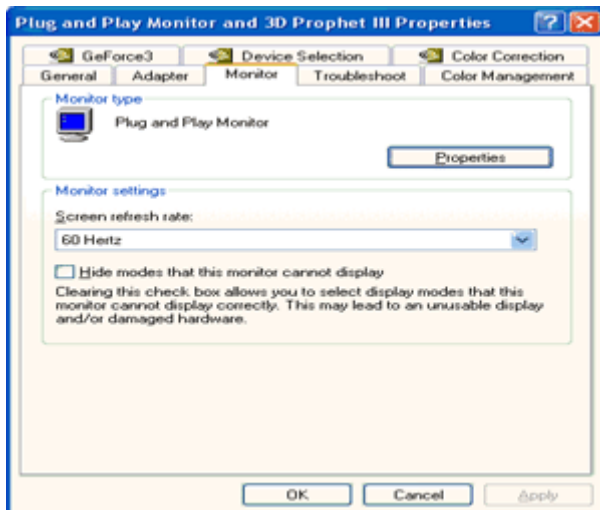

7. Click on the 'Driver' tab and then click on 'Update Driver...' button.

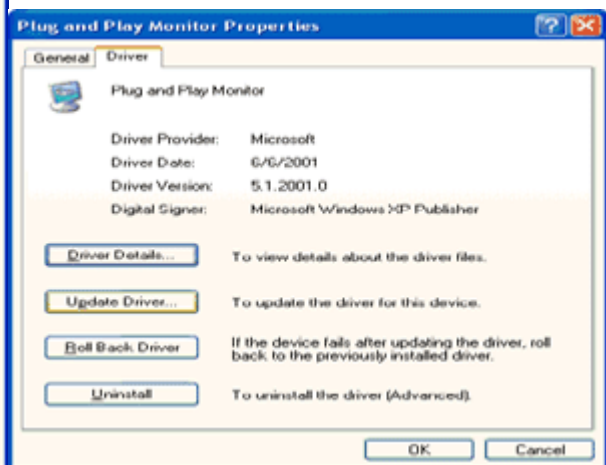
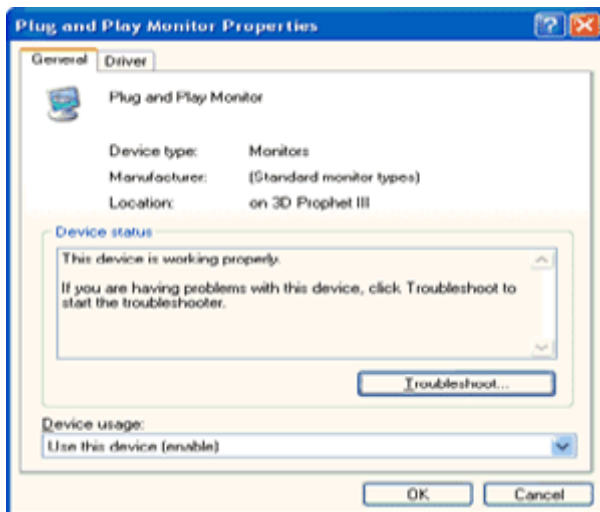

8. Select the 'Install from a list or specific location [advanced]' radio button and then click on the 'Next' button.

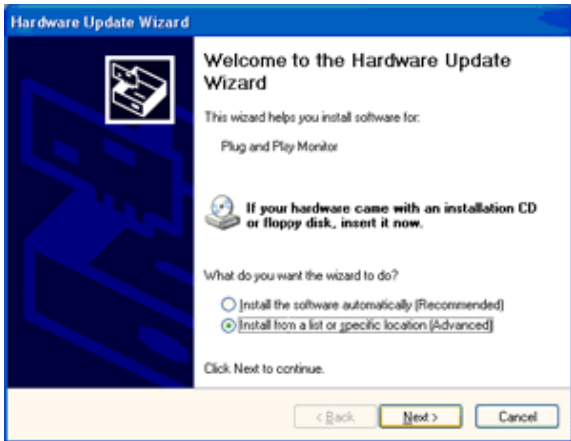

9. Select the 'Don't Search. I will choose the driver to install' radio button. Then click on the 'Next' button.

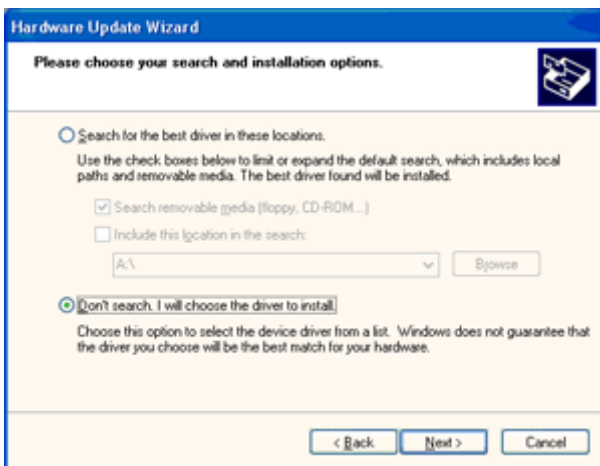

10. Click on the 'Have disk...' button, then click on the 'Browse...' button and then select the appropriate drive F: (CD-ROM Drive).

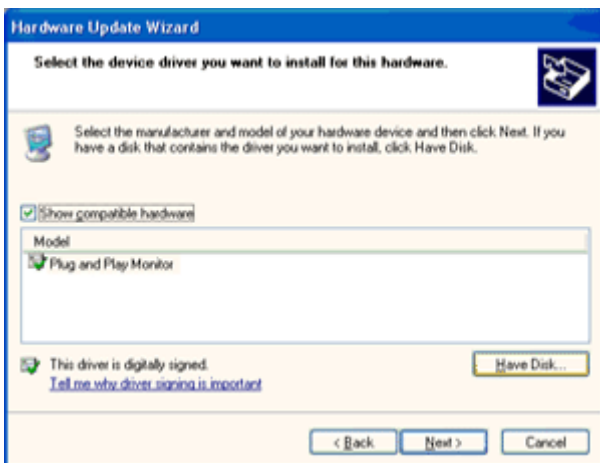

11. Click on the 'Open' button, then click the 'OK' button.

12. Select your monitor model and click on the 'Next' button.

- If you can see the 'has not passed Windows® Logo testing to verify its compatibility with Windows® XP' message, please click on the 'Continue Anyway' button.

13. Click on the 'Finish' button then the 'Close' button.

14. Click on the 'OK' button and then the 'OK' button again to close the Display Properties dialog box.

## Windows 2000

1. Start Windows® 2000
  2. Click on the 'Start' button, point to 'Settings', and then click on 'Control Panel'.
  3. Double click on the 'Display' Icon.
  4. Select the 'Settings' tab then click on 'Advanced...'
  5. Select 'Monitor'
    - If the 'Properties' button is inactive, it means your monitor is properly configured. Please stop installation.
    - If the 'Properties' button is active. Click on 'Properties' button. Please follow the steps given below.
  6. Click on 'Driver' and then click on 'Update Driver...' then click on the 'Next' button.
  7. Select 'Display a list of the known drivers for this device so that I can choose a specific driver', then click on 'Next' and then click on 'Have disk...'
  8. Click on the 'Browse...' button then select the appropriate drive F: ( CD-ROM Drive).
  9. Click on the 'Open' button, then click on the 'OK' button.
  10. Select your monitor model and click on the 'Next' button.
  11. Click on the 'Finish' button then the 'Close' button.
- If you can see the 'Digital Signature Not Found' window, click on the 'Yes' button.

## Windows ME

1. Start Windows® Me
2. Click on the 'Start' button, point to 'Settings', and then click on 'Control Panel'.
3. Double click on the 'Display' Icon.
4. Select the 'Settings' tab then click on 'Advanced...'
5. Select the 'Monitor' button, then click on 'Change...' button.
6. Select 'Specify the location of the driver(Advanced)' and click on the 'Next' button.
7. Select 'Display a list of all the drivers in a specific location, so you can choose the driver you want', then click on 'Next' and then click on 'Have Disk...'
8. Click on the 'Browse...' button, select the appropriate drive F: ( CD-ROM Drive) then click on the 'OK' button.
9. Click on the 'OK' button, select your monitor model and click on the 'Next' button.
10. Click on 'Finish' button then the 'Close' button.

# i-Menu



Welcome to "i-Menu" software by AOC. i-Menu makes it easy to adjust your monitor display setting by using on screen menus instead of the OSD button on the monitor. To complete installation, please follow the installation guide.





# Troubleshoot

Problem & Question	Possible Solutions
<b>Power LED Is Not ON</b>	Make sure the power button is ON and the Power Cord is properly connected to a grounded power outlet and to the monitor.
<b>No images on the screen</b>	<ul style="list-style-type: none"> <li>• Is the power cord connected properly? Check the power cord connection and power supply.</li> <li>• Is the cable connected correctly? (Connected using the D-sub cable) Check the DB-15 cable connection. (Connected using the DVI cable) Check the DVI cable connection. * DVI input is not available on every model.</li> <li>• If the power is on, reboot the computer to see the initial screen (the login screen), which can be seen. If the initial screen (the login screen) appears, boot the computer in the applicable mode (the safe mode for Windows ME/XP/2000) and then change the frequency of the video card. (Refer to the Setting the Optimal Resolution) If the initial screen (the login screen) does not appear, contact the Service Center or your dealer.</li> <li>• Can you see "Input Not Supported" on the screen? You can see this message when the signal from the video card exceeds the maximum resolution and frequency that the monitor can handle properly. Adjust the maximum resolution and frequency that the monitor can handle properly.</li> <li>• Make sure the AOC Monitor Drivers are installed.</li> </ul>
<b>Picture Is Fuzzy &amp; Has Ghosting Shadowing Problem</b>	<p>Adjust the Contrast and Brightness Controls. Press to auto adjust.</p> <p>Make sure you are not using an extension cable or switch box. We recommend plugging the monitor directly to the video card output connector on the back .</p>
<b>Picture Bounces, Flickers Or Wave Pattern Appears In The Picture</b>	<p>Move electrical devices that may cause electrical interference as far away from the monitor as possible.</p> <p>Use the maximum refresh rate your monitor is capable of at the resolution your are using.</p>

<p><b>Monitor Is Stuck In Active Off-Mode"</b></p>	<p>The Computer Power Switch should be in the ON position.  The Computer Video Card should be snugly fitted in its slot.  Make sure the monitor's video cable is properly connected to the computer.  Inspect the monitor's video cable and make sure no pin is bent.  Make sure your computer is operational by hitting the CAPS LOCK key on the keyboard while observing the CAPS LOCK LED. The LED should either turn ON or OFF after hitting the CAPS LOCK key.</p>
<p><b>Missing one of the primary colors (RED, GREEN, or BLUE)</b></p>	<p>Inspect the monitor's video cable and make sure that no pin is damaged.  Make sure the monitor's video cable is properly connected to the computer.</p>
<p><b>Screen image is not centered or sized properly</b></p>	<p>Adjust H-Position and V-Position or press hot-key (AUTO).</p>
<p><b>Picture has color defects (white does not look white)</b></p>	<p>Adjust RGB color or select desired color temperature.</p>
<p><b>Horizontal or vertical disturbances on the screen</b></p>	<p>Use Windows 95/98/2000/ME/XP shut-down mode Adjust CLOCK and FOCUS.  Press to auto-adjust.</p>

# Specification

## General Specification

Panel	Model number	N941Sw
	Driving system	TFT Color LCD
	Viewable Image Size	47cm diagonal
	Pixel pitch	0.3mm(H) x 0.3mm(V)
	Video	R, G, B Analog Interface
	Separate Sync.	H/V TTL
	Display Color	16.7M Colors
	Dot Clock	85.5 MHz
Resolution	Horizontal scan range	30 kHz - 60 kHz
	Horizontal scan Size(Maximum)	409.8mm
	Vertical scan range	55 Hz - 75 Hz
	Vertical scan Size(Maximum)	230.4mm
	Optimal preset resolution	1366 x 768 (60 Hz)
	Highest preset resolution	1366 x 768 (60 Hz)
	Plug & Play	VESA DDC2B/CI
	Input Connector	D-Sub 15pin
	Input Video Signal	Analog: 0.7Vp-p(standard), 75 OHM, Positive
	Power Source	100~240VAC, 50/60Hz
	Power Consumption	Active < 23 W Standby < 0.1 W
Physical Characteristics	Connector Type	15-pin Mini D-Sub
	Signal Cable Type	Detachable
	Dimensions & Weight:	
	Height (with base)	348.9 mm
	Width	457.9 mm
	Depth	149.8 mm
	Weight (monitor only)	3.0 kg
Environmental	Temperature:	
	Operating	0°C to 40° C
	Non-Operating	-25°C to 55°C
	Humidity:	
	Operating	10% to 85% (non-condensing)
	Non-Operating	5% to 93% (non-condensing)

	Altitude:	
	Operating	0~ 3,658m (0~ 12,000 ft )
	Non-Operating	0~ 12,192m (0~ 40,000 ft )

## Preset Display Modes

STAND	RESOLUTION	HORIZONTAL FREQUENCY(KHZ)	VERTICAL FREQUENCY(Hz)
VGA	640x480 @60Hz	31.469	59.940
VGA	640x480 @67Hz	35.000	66.667
VGA	640x480 @72Hz	37.861	72.809
VGA	640x480 @75Hz	37.500	75.000
Dos-mode	720x400 @70Hz	31.469	70.087
SVGA	800x600 @56Hz	35.156	56.250
SVGA	800x600 @60Hz	37.879	60.317
SVGA	800x600 @72Hz	48.077	72.188
SVGA	800x600 @75Hz	46.875	75.000
Mac-mode	832x624 @75Hz	49.725	74.551
XGA	1024x768 @60Hz	48.363	60.004
XGA	1024x768 @70Hz	56.476	70.069
XGA	1024x768 @72Hz	57.500	72.074
XGA	1024x768 @75Hz	60.023	75.029
wXGA	1280x720@60Hz	45.000	60.000
wXGA	1366x768@60Hz	47.712	59.790

## Pin Assignments

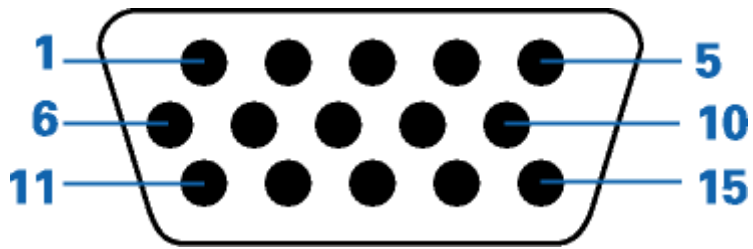

Pin Number	15-Pin Side of the Signal Cable
1	Video-Red
2	Video-Green
3	Video-Blue
4	N.C.
5	Detect Cable
6	GND-R
7	GND-G
8	GND-B
9	+5V
10	Ground
11	N.C.
12	DDC-Serial data
13	H-sync
14	V-sync
15	DDC-Serial clock

# Plug and Play

## Plug & Play DDC2B Feature

This monitor is equipped with VESA DDC2B capabilities according to the VESA DDC STANDARD. It allows the monitor to inform the host system of its identity and, depending on the level of DDC used, communicate additional information about its display capabilities.

The DDC2B is a bi-directional data channel based on the I2C protocol. The host can request EDID information over the DDC2B channel.

# Regulation

## FCC Notice

### **FCC Class B Radio Frequency Interference Statement WARNING: (FOR FCC CERTIFIED MODELS)**

NOTE: This equipment has been tested and found to comply with the limits for a Class B digital device, pursuant to Part 15 of the FCC Rules. These limits are designed to provide reasonable protection against harmful interference in a residential installation. This equipment generates, uses and can radiate radio frequency energy, and if not installed and used in accordance with the instructions, may cause harmful interference to radio communications. However, there is no guarantee that interference will not occur in a particular installation. If this equipment does cause harmful interference to radio or television reception, which can be determined by turning the equipment off and on, the user is encouraged to try to correct the interference by one or more of the following measures:

Reorient or relocate the receiving antenna.

Increase the separation between the equipment and receiver.

Connect the equipment into an outlet on a circuit different from that to which the receiver is connected.

Consult the dealer or an experienced radio/TV technician for help.

### **NOTICE :**

The changes or modifications not expressly approved by the party responsible for compliance could void the user's authority to operate the equipment.

Shielded interface cables and AC power cord, if any, must be used in order to comply with the emission limits.

The manufacturer is not responsible for any radio or TV interference caused by unauthorized modification to this equipment. It is the responsibilities of the user to correct such interference. It is the responsibility of the user to correct such interference.

## WEEE Declaration

Disposal of Waste Equipment by Users in Private Household in the European Union.



This symbol on the product or on its packaging indicates that this product must not be disposed of with your other household waste. Instead, it is your responsibility to dispose of your waste equipment by handing it over to a designated collection point for the recycling of waste electrical and electronic equipment. The separate collection and recycling of your waste equipment at the time of disposal will help to conserve natural resources and ensure that it is recycled in a manner that protects human health and the environment. For more information about where you can drop off your waste equipment for recycling, please contact your local city office, your household waste disposal service or the shop where you purchased the product .

## HG Declaration



SAFETY: Lamp Disposal

LAMP(S) INSIDE THIS PRODUCT CONTAIN MERCURY AND MUST BE RECYCLED OR DISPOSED OF ACCORDING TO LOCAL, STATE OR FEDERAL LAWS. FOR MORE INFORMATION, CONTACT THE ELECTRONIC INDUSTRIES ALLIANCE AT [WWW.EIAE.ORG](http://WWW.EIAE.ORG).



# EPEAT Declaration



EPEAT is a system to help purchasers in the public and private sectors evaluate, compare and select desktop computers, notebooks and monitors based on their environmental attributes. EPEAT also provides a clear and consistent set of performance criteria for the design of products, and provides an opportunity for manufacturers to secure market recognition for efforts to reduce the environmental impact of its products.

AOC believes in protecting the environment.

With a key concern for the conservation of natural resources, as well as landfill protection, AOC announces the launch of AOC monitor's packaging recycling program. This program is designed to help you discard of your monitor carton and filler materials properly. If a local recycling center is not available, AOC will recycle the packaging material for you, including foam filler and carton. AOC Display solution will only recycle AOC monitor packaging. Please refer to the following website address:

**Only for North and South American, excluding Brazil:**

[http://us.aoc.com/about/environmental\\_impact](http://us.aoc.com/about/environmental_impact)

**For Germany:**

<http://www.aoc-europe.com/en/service/tco.php>

**For Brazil:**

[http://www.aoc.com.br/2007/php/index.php?req=pagina&pgn\\_id=134](http://www.aoc.com.br/2007/php/index.php?req=pagina&pgn_id=134)

# Service

## Warranty Statement for Europe

### LIMITED THREE-YEAR WARRANTY\*

AOC Color Monitors sold within Europe

AOC International (Europe) GmbH warrants this product to be free from defects in material and workmanship for a period of Three (3) years after the original date of consumer purchase. During this period, AOC International (Europe) GmbH will, at its option, either repair the defective product with new or rebuilt parts, or replace it with a new or rebuilt product at no charge except as \*stated below. The defective products that are replaced become the property of AOC International (Europe) GmbH.

If the product appears to be defective, please contact your local dealer or refer to the warranty card when attached to the product.

Deliver the product freight pre-paid, along with the dated proof of purchase, to the AOC Authorized Service Center. If you cannot deliver the product in person:

- Pack it in its original shipping container (or equivalent)
- Put the RMA number on the address label
- Put the RMA number on the shipping carton
- Insure it (or assume the risk of loss/damage during shipment)
- Pay all shipping charges

AOC International (Europe) GmbH is responsible neither for any damage or loss during inbound transport damage nor to inbound product that was not properly packaged.

AOC International (Europe) GmbH will pay the return shipping charges within one of the countries specified within this warranty statement. AOC International (Europe) GmbH is not responsible for any costs associated with the transportation of product across international borders. This includes the international border within the European Union.

\* This limited warranty does not cover any losses or damages that occur as a result of

- Shipping or improper installation or maintenance
- Misuse
- Neglect
- Any cause other than ordinary commercial or industrial application
- Adjustment by non-authorized source
- Repair, modification, or installation of options or parts by anyone other than an AOC Authorized Service Center
- Improper environment
- Excessive or inadequate heating or air conditioning or electrical powers failures, surges, or other irregularities

This limited warranty does not cover any of the product firmware or hardware that you or any third party have

modified or altered; you bear the sole responsibility and liability for any such modification or alteration.

ALL EXPRESS AND IMPLIED WARRANTIES FOR THIS PRODUCT (INCLUDING THE WARRANTIES OF MERCHANTABILITY AND FITNESS FOR A PARTICULAR PURPOSE) ARE LIMITED IN DURATION TO A PERIOD OF THREE (3) YEARS FOR PARTS AND LABOR FROM THE ORIGINAL DATE OF CONSUMER PURCHASE. NO WARRANTIES (EITHER EXPRESSED OR IMPLIED) APPLY AFTER THIS PERIOD.

AOC INTERNATIONAL (EUROPE) GMBH OBLIGATIONS AND YOUR REMEDIES HEREUNDER ARE SOLELY AND EXCLUSIVELY AS STATED HERE. AOC INTERNATIONAL (EUROPE) GMBH LIABILITY, WHETHER BASED ON CONTRACT, TORT, WARRANTY, STRICT LIABILITY, OR OTHER THEORY, SHALL NOT EXCEED THE PRICE OF THE INDIVIDUAL UNIT WHOSE DEFECT OR DAMAGE IS THE BASIS OF THE CLAIM. IN NO EVENT SHALL AOC INTERNATIONAL (EUROPE) GMBH BE LIABLE FOR ANY LOSS OF PROFITS, LOSS OF USE OR FACILITIES OR EQUIPMENT, OR OTHER INDIRECT, INCIDENTAL, OR CONSEQUENTIAL DAMAGE. SOME STATES DO NOT ALLOW THE EXCLUSION OR LIMITATION OF INCIDENTAL OR CONSEQUENTIAL DAMAGES, SO THE ABOVE LIMITATION MAY NOT APPLY TO YOU. ALTHOUGH THIS LIMITED WARRANTY GIVES YOU SPECIFIC LEGAL RIGHTS, YOU MAY HAVE OTHER RIGHTS, WHICH MAY VARY FROM COUNTRY TO COUNTRY. THIS LIMITED WARRANTY IS ONLY VALID FOR PRODUCTS PURCHASED IN THE MEMBER COUNTRIES OF THE EUROPEAN UNION.

Information in this document is subject to change without notice.

For more details, please visit: <http://www.aoc-europe.com/en/service/index.php>

## Warranty Statement for North & South America (excluding Brazil)

WARRANTY STATEMENT  
for AOC Color Monitors  
Including those Sold within North America as Specified

Envision Peripherals, Inc. warrants this product to be free from defects in material and workmanship for a period of three (3) years for parts & labor and one (1) year for CRT Tube or LCD Panel after the original date of consumer purchase. During this period, EPI ( EPI is the abbreviation of Envision Peripherals, Inc. ) will, at its option, either repair the defective product with new or rebuilt parts, or replace it with a new or rebuilt product at no charge except as \*stated below. The parts or product that are replaced become the property of EPI.

In the USA to obtain service under this limited warranty, call EPI for the name of the Authorized Service Center closest to your area. Deliver the product freight pre-paid, along with the dated proof of purchase, to the EPI Authorized Service Center. If you cannot deliver the product in person:

- Pack it in its original shipping container (or equivalent)
- Put the RMA number on the address label
- Put the RMA number on the shipping carton
- Insure it (or assume the risk of loss/damage during shipment)
- Pay all shipping charges

EPI is not responsible for damage to inbound product that was not properly packaged.

EPI will pay the return shipment charges within one of the countries specified within this warranty statement. EPI is not responsible for any costs associated with the transportation of product across international borders. This includes the international borders of the countries within this warranty statements.

In the United States and Canada contact your Dealer or EPI Customer Service, RMA Department at the toll free number (888) 662-9888. Or you can request an RMA Number online at [www.aoc.com/na-warranty](http://www.aoc.com/na-warranty).

\* This limited warranty does not cover any losses or damages that occur as a result of:

- Shipping or improper installation or maintenance
- Misuse
- Neglect
- Any cause other than ordinary commercial or industrial application
- Adjustment by non-authorized source
- Repair, modification, or installation of options or parts by anyone other than an EPI Authorized Service Center
- Improper environment
- Excessive or inadequate heating or air conditioning or electrical power failures, surges, or other irregularities

This three-year limited warranty does not cover any of the product's firmware or hardware that you or any third party have modified or altered; you bear the sole responsibility and liability for any such modification or alteration.

ALL EXPRESS AND IMPLIED WARRANTIES FOR THIS PRODUCT (INCLUDING THE WARRANTIES OF MERCHANTABILITY AND FITNESS FOR A PARTICULAR PURPOSE) ARE LIMITED IN DURATION TO A PERIOD OF THREE (3) YEARS FOR PARTS AND LABOR AND ONE (1) YEAR FOR CRT TUBE OR LCD PANEL FROM THE ORIGINAL DATE OF CONSUMER PURCHASE. NO WARRANTIES (EITHER EXPRESSED OR IMPLIED) APPLY AFTER THIS PERIOD. IN THE UNITED STATES OF AMERICA, SOME STATES DO NOT ALLOW LIMITATIONS ON HOW LONG AN IMPLIED WARRANTY LASTS, SO THE ABOVE LIMITATIONS MAY NOT APPLY TO YOU.

EPI OBLIGATIONS AND YOUR REMEDIES HEREUNDER ARE SOLELY AND EXCLUSIVELY AS STATED HERE. EPI' LIABILITY, WHETHER BASED ON CONTRACT, TORT, WARRANTY, STRICT LIABILITY, OR OTHER THEORY, SHALL NOT EXCEED THE PRICE OF THE INDIVIDUAL UNIT WHOSE DEFECT OR DAMAGE IS THE BASIS OF THE CLAIM. IN NO EVENT SHALL ENVISION PERIPHERALS, INC. BE LIABLE FOR ANY LOSS OF PROFITS, LOSS OF USE OR FACILITIES OR EQUIPMENT OR OTHER INDIRECT, INCIDENTAL, OR CONSEQUENTIAL DAMAGE. IN THE UNITED STATES OF AMERICA, SOME STATES DO NOT ALLOW THE EXCLUSION OR LIMITATION OF INCIDENTAL OR CONSEQUENTIAL DAMAGES. SO THE ABOVE LIMITATION MAY NOT APPLY TO YOU. ALTHOUGH THIS LIMITED WARRANTY GIVES YOU SPECIFIC LEGAL RIGHTS. YOU MAY HAVE OTHER RIGHTS WHICH MAY VARY FROM STATE TO STATE.

In the United States of America, this limited warranty is only valid for Products purchased in the Continental United States, Alaska, and Hawaii.

Outside the United States of America, this limited warranty is only valid for Products purchased in Canada.

Information in this document is subject to change without notice.

For more details, please visit:

**USA:** [http://us.aoc.com/support/find\\_service\\_center](http://us.aoc.com/support/find_service_center)  
**ARGENTINA:** [http://ar.aoc.com/support/find\\_service\\_center](http://ar.aoc.com/support/find_service_center)  
**BOLIVIA:** [http://bo.aoc.com/support/find\\_service\\_center](http://bo.aoc.com/support/find_service_center)  
**CHILE:** [http://cl.aoc.com/support/find\\_service\\_center](http://cl.aoc.com/support/find_service_center)  
**COLOMBIA:** [http://co.aoc.com/support/find\\_service\\_center](http://co.aoc.com/support/find_service_center)  
**COSTA RICA:** [http://cr.aoc.com/support/find\\_service\\_center](http://cr.aoc.com/support/find_service_center)  
**DOMINICAN REPUBLIC:** [http://do.aoc.com/support/find\\_service\\_center](http://do.aoc.com/support/find_service_center)  
**ECUADOR:** [http://ec.aoc.com/support/find\\_service\\_center](http://ec.aoc.com/support/find_service_center)  
**EL SALVADOR:** [http://sv.aoc.com/support/find\\_service\\_center](http://sv.aoc.com/support/find_service_center)  
**GUATEMALA:** [http://gt.aoc.com/support/find\\_service\\_center](http://gt.aoc.com/support/find_service_center)  
**HONDURAS:** [http://hn.aoc.com/support/find\\_service\\_center](http://hn.aoc.com/support/find_service_center)  
**NICARAGUA:** [http://ni.aoc.com/support/find\\_service\\_center](http://ni.aoc.com/support/find_service_center)  
**PANAMA:** [http://pa.aoc.com/support/find\\_service\\_center](http://pa.aoc.com/support/find_service_center)  
**PARAGUAY:** [http://py.aoc.com/support/find\\_service\\_center](http://py.aoc.com/support/find_service_center)  
**PERU:** [http://pe.aoc.com/support/find\\_service\\_center](http://pe.aoc.com/support/find_service_center)  
**URUGUAY:** [http://pe.aoc.com/support/find\\_service\\_center](http://pe.aoc.com/support/find_service_center)  
**VENEZUELA:** [http://ve.aoc.com/support/find\\_service\\_center](http://ve.aoc.com/support/find_service_center)  
**IF COUNTRY NOT LISTED:** [http://latin.aoc.com/support/find\\_service\\_center](http://latin.aoc.com/support/find_service_center)

## Warranty Statement for AP

### LIMITED THREE-YEAR WARRANTY\* AOC Color Monitors sold within AP

AOC is one internal brand for its professional monitor ,TV technology ,affordable price and available service .Customer satisfaction-oriented is always what we are pursuing .

We provide 3 years standard warranty for AOC monitor and 1-3 years standard warranty for AOC TV .However There is some slight warranty difference due to AOC different service strategic in different area/country ,so any question against warranty or any other AOC products warranty ,please leave the message via [service.support@aoc.com](mailto:service.support@aoc.com) .or check with the dealer or reseller in your country where you bought the product .We will response to you with top priority .

AOC warrants this product to be free from defects in material and workmanship .

During the warranty period, TPV will, at its option, either repair the defective product with new or rebuilt parts, or replace it with a new or rebuilt product at no charge except as \*stated below. The defective products that are replaced become the property of AOC.

- \*This limited warranty does not cover any losses or damages that occur as a result of
- Shipping or improper installation or maintenance
- Misuse or Neglect
- Any cause other than ordinary application
- Adjustment by non-authorized source
- Repair, modification, or installation of options or parts by anyone other than an AOC Authorized Service Center
- Improper environment- Excessive or inadequate heating or air conditioning or electrical powers failures, surges or other irregularities
- Fire, flood, earthquake, terrorist attack or other accidents

This limited warranty does not cover any of the product firmware or hardware that you or any third party have modified or altered; customer bear the sole responsibility and liability for any such modification or alteration.

It's the right of AOC to issue or terminate the warranty terms. For exception cases, subject to report of our investigation, we reserve the right to terminate or modify terms of warranty policy.

#### How to get your Warranty ?

1. Please keep the purchase invoice ,and our service partner will take over the service against the invoice
2. If you can not show the invoice ,please contact local dealer /.reseller for getting special support